



# ALFRA DIN RAIL CUTTING UNIT – ALC-02

MADE IN GERMANY BY ALFRA

## For DIN carrier rails with hand lever operation

Exactly and easily cuts profile and earthing rails.  
Standard version for TS 35/7.5 - 35/15 - 15/5.5 - Cu 10.0 x 3.0 mm

- With reinforced eccentric that lies directly above the shearing blade
- Less use of force due to better force transfer
- Burr-free cutting without loss
- Maintenance free
- Length stop 1000 mm
- Shearing blade can be resharpened
- Guide apparatus for exactly cutting a 90°-angle
- Easy assembly on the work bench
- Also special fabrications are possible  
(Please send in sample rails of approx. 1000 mm length).

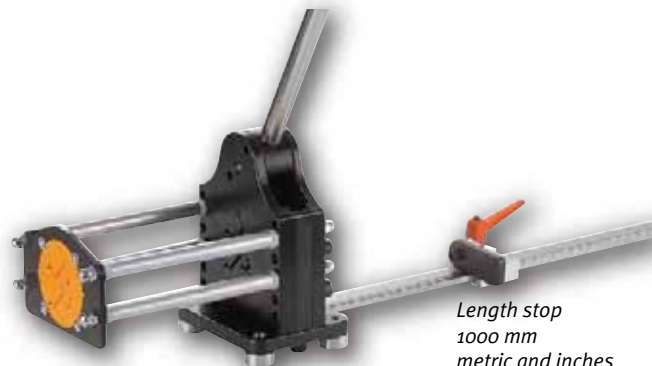

Length stop  
1000 mm  
metric and inches

**Prod.-No.**  
03004

Guide apparatus  
for exactly cutting 90°-angles

Standard version, complete with length stop  
and guiding apparatus

## Standard version

Carrier rail 35 mm/7.5  
accord. to EN 50.022

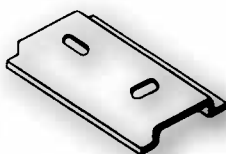
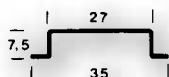

Carrier rail 35 mm/15  
accord. to EN 50.022

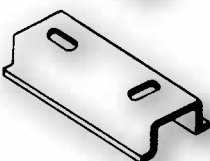
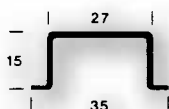

Carrier rail 15 mm/5.5  
accord. to EN 50 045

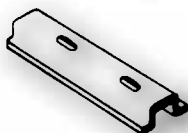

Copper earthing rail  
10 mm x 3 mm

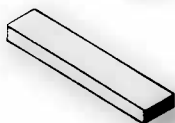

Prod.-No. 03004

**Special fabrication for special profiles like  
e.g. cable ducts upon request!**

